

## ECO-SLIM 62TT - CATALOGO FULL EDITION





### Correzione sagomario ed elenco profili

Si segnala che nel catalogo Ecoslim 62TT (Full Edition, v1.0\*) sono state apportate le correzioni che seguono:

- Pagina 25: correzione codice profilo TT 61847 (codice errato ~~TT 11647~~).
- Pagina 36: correzione codice profilo TT 61847 (codice errato ~~TT 11647~~).
- Pagina 37-38: inserimento pesi profili fermavetro.

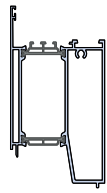
\*ATTENZIONE: per verificare la versione del catalogo in vostro possesso controllare il numero di edizione riportato in corrispondenza del pedice di ogni pagina e sul retro di copertina accanto al QR-Code.

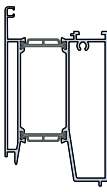
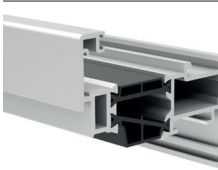
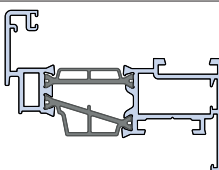
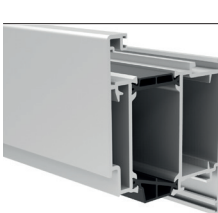
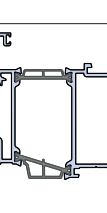
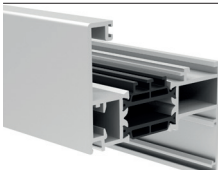
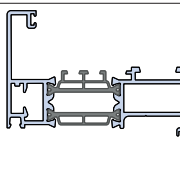
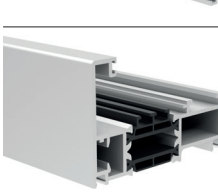
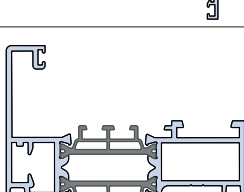
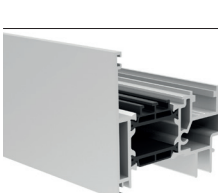
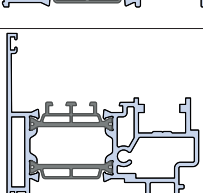
EasyDoor
Ecoslim 50 TT
Ecoslim 62 TT
Ecoslim 72 TT
Elite Door 72
Door 62
Door 72
Sirio 50
Smart 30
Planet 45
Planet 50 TT
Planet 50 PLUS
Planet 62 TT
Planet 62 PLUS
Planet 72 HT
Planet 72 PLUS
3G
Fullglazing
Matic 50
Matic 50 PLUS
Matic 62 TT
Matic 62 PLUS
Matic 72
Matic 72 PLUS
3G Matic
Nathura 59
Nathura 70
Nathura 82
Nathura 92
Slide 60
Slide 65
Slide 80/106 PLUS
Topslide 160
Topslide 160 PLUS
Slidewood 160
Topslidewood 214
Panoramico
Balconi e balaustre

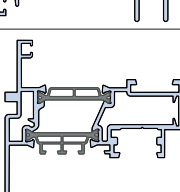
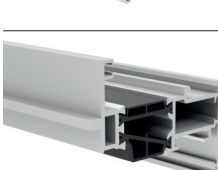
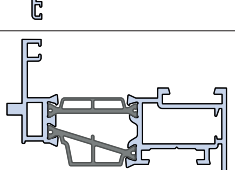
	Sagoma	Art.	Descrizione	Jxx cm <sup>4</sup> Jyy cm <sup>4</sup>
		TT 61847	Zoccolo di riporto per telai fissi <i>Fitted base for fixed frame</i>	84,88 43,96
		TT 11648	Zoccolo di riporto per ante <i>Fitted base for leaf</i>	84,39 47,57
		TT 11677	Anta normale <i>Flat leaf</i>	6,31 27,30
		TT 11678	Anta maggiorata <i>Oversized leaf</i>	40,73 46,27
		TT 12602	Telaio a Z IRON muro 66mm, battuta 25mm <i>IRON Z frame for wall 66mm, beat 25mm</i>	10,18 32,73
		TT 12603	Telaio a L IRON <i>IRON L frame</i>	6,52 25,97
		TT 12613	Riporto centrale MATIC <i>MATIC astragal</i>	9,46 28,28
		TT 12614	Profilo T all'italiana IRON <i>IRON T italian leaf</i>	9,58 30,35
		TT 12627	Anta IRON normale <i>IRON flat leaf</i>	5,52 25,89

SAGOMARIO  
Profile representation

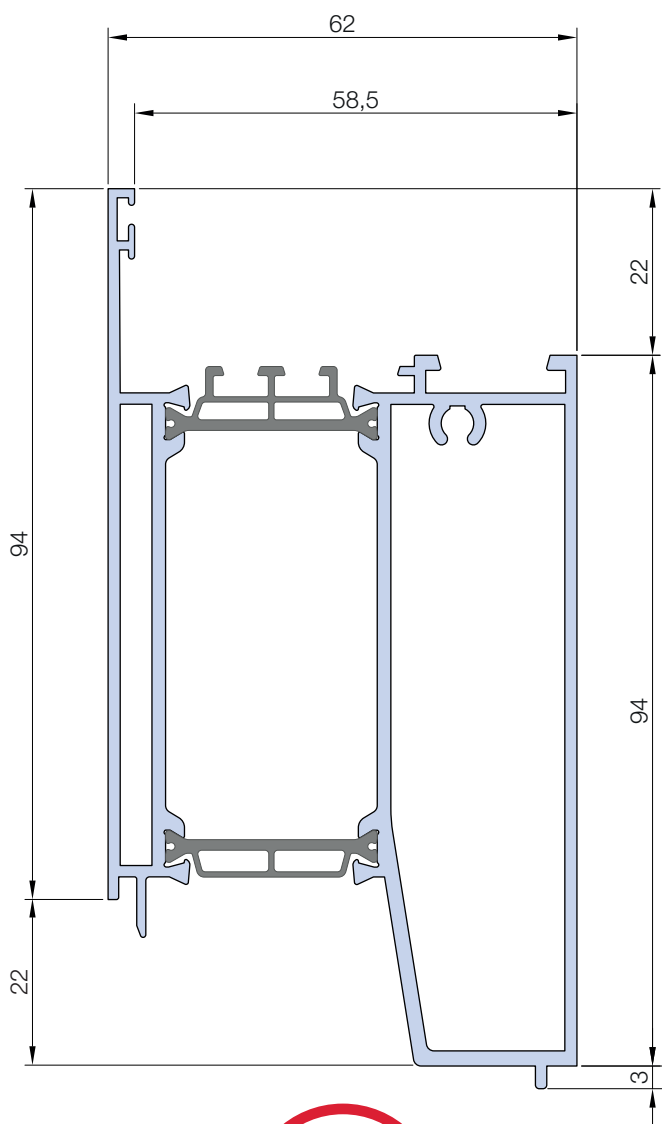

TT 61847

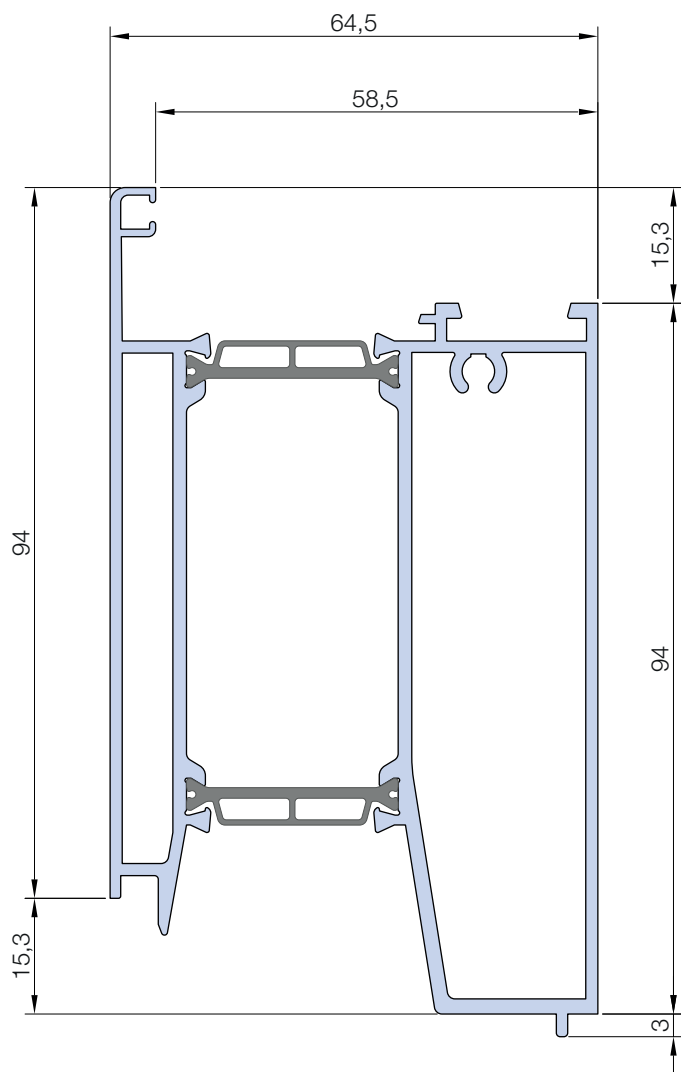

TT 11648

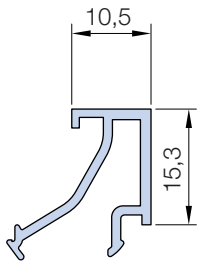

**PL 1110**  
200 g/m

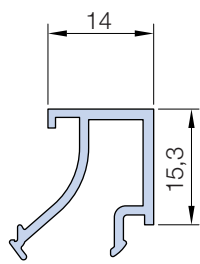

**PL 1114**  
207 g/m

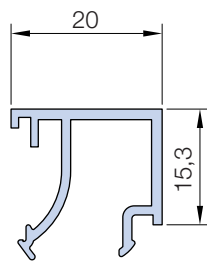

**PL 1120**  
235 g/m

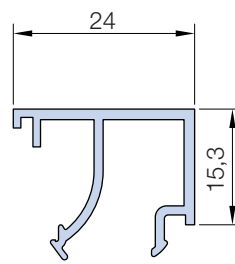

**PL 1124**  
251 g/m

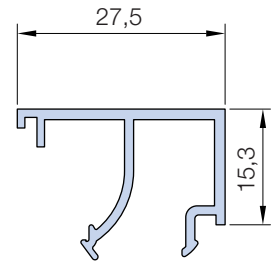

**PL 1128**  
264 g/m

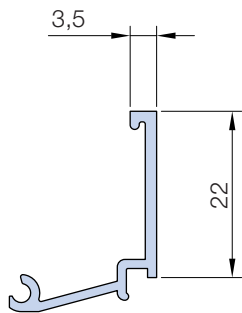

**PL 1404\***  
190 g/m

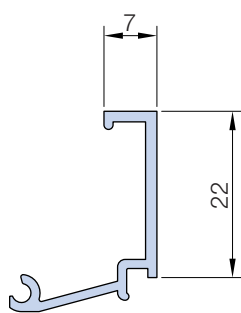

**PL 1407\***  
206 g/m

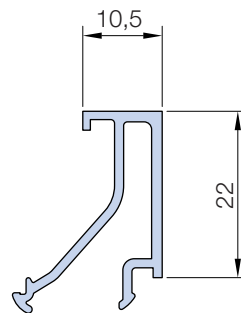

**PL 1411**  
252 g/m

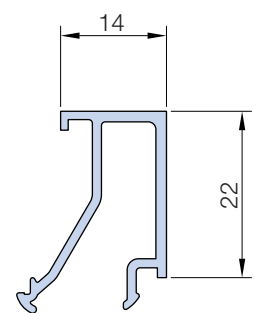

**PL 1414**  
257 g/m

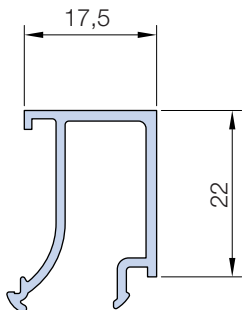

**PL 1418**  
268 g/m

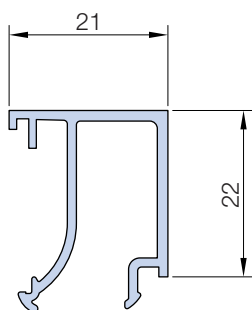

**PL 1421**  
290 g/m

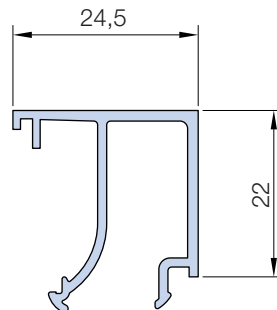

**PL 1425**  
304 g/m

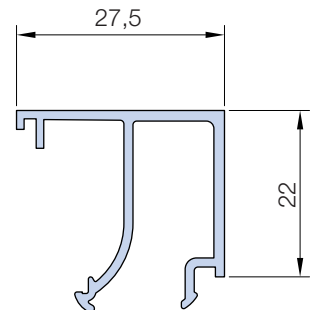

**PL 1428**  
312 g/m

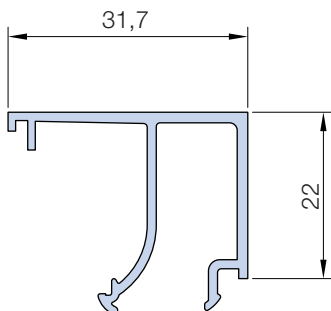

**PL 1432**  
331 g/m

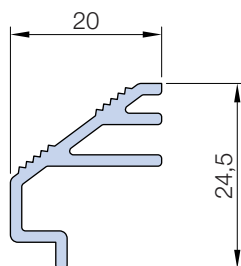

**PL 20126**  
260 g/m

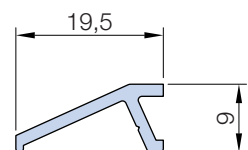

**PL 20100**  
129 g/m

SAGOMARIO  
Profile representation

\* UTILIZZARE SEMPRE ACP 5027/ \* Use ACP 5027 always

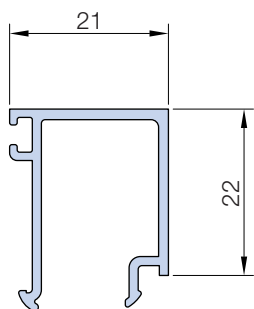

**PL 14121**

280 g/m

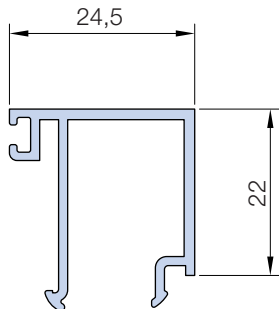

**PL 14125**

313 g/m

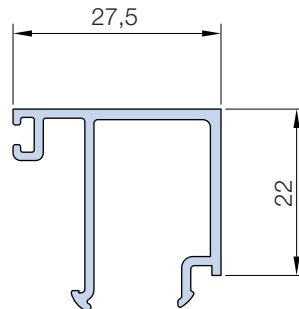

**PL 14128**

323 g/m

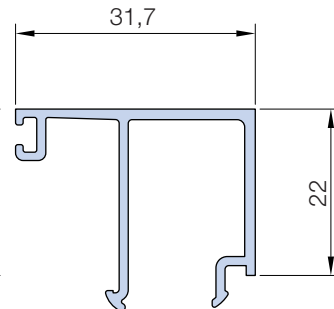

**PL 14132**

338 g/m

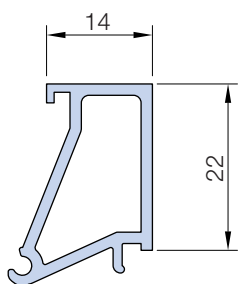

**PL 14214\***

329 g/m

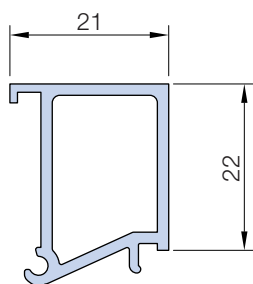

**PL 14221\***

353 g/m

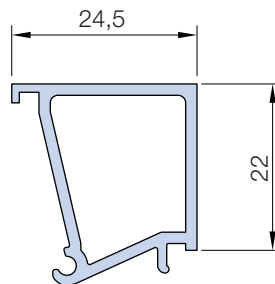

**PL 14225\***

370 g/m

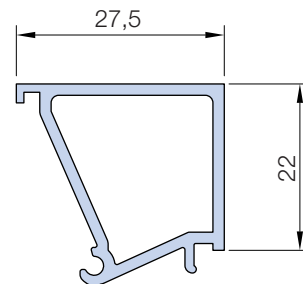

**PL 14228\***

389 g/m

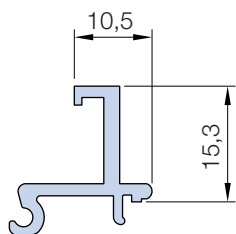

**PL 11411\***

231 g/m

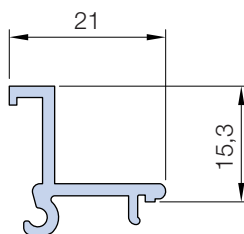

**PL 11421\***

201 g/m

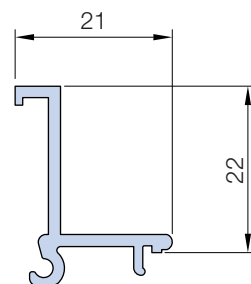

**PL 14421\***

353 g/m

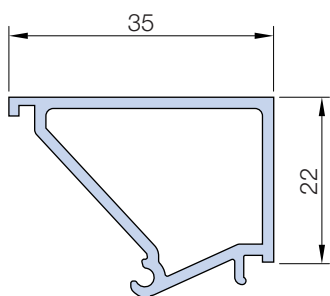

**PL 1435\***

434 g/m

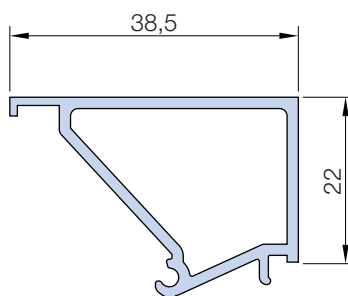

**PL 1439\***

445 g/m

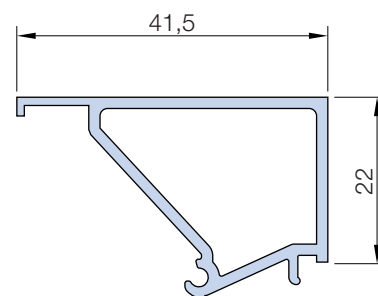

**PL 1442\***

454 g/m

\* UTILIZZARE SEMPRE ACP 5027/ \* Use ACP 5027 always